

Price List

Valid From April.2009



Bio Concept			Price (€)
P/N	Description	Size	ALV (0%)
013010	Standard Implant, φ3.3mm RN, SLA 8.0mm	B 48/28/33/8	152,00
013020	Standard Implant, φ3.3mm RN, SLA 10.0mm	B 48/28/33/10	152,00
013030	Standard Implant, φ3.3mm RN, SLA 12.0mm	B 48/28/33/12	152,00
013040	Standard Implant, φ3.3mm RN, SLA 14.0mm	B 48/28/33/14	152,00
013050	Standard Implant, φ3.3mm RN, SLA 16.0mm	B 48/28/33/16	152,00
013060	Standard Implant, φ4.1mm RN, SLA 6.0mm	B 48/28/41/6	152,00
013070	Standard Implant, φ4.1mm RN, SLA 8.0mm	B 48/28/41/8	152,00
013080	Standard Implant, φ4.1mm RN, SLA 10.0mm	B 48/28/41/10	152,00
013090	Standard Implant, φ4.1mm RN, SLA 12.0mm	B 48/28/41/12	152,00
013100	Standard Implant, φ4.1mm RN, SLA 14.0mm	B 48/28/41/14	152,00
013110	Standard Implant, φ4.1mm RN, SLA 16.0mm	B 48/28/41/16	152,00
013120	Standard Implant, φ4.8mm RN, SLA 6.0mm	B 48/28/48/6	152,00
013130	Standard Implant, φ4.8mm RN, SLA 8.0mm	B 48/28/48/8	152,00
013140	Standard Implant, φ4.8mm RN, SLA 10.0mm	B 48/28/48/10	152,00
013150	Standard Implant, φ4.8mm RN, SLA 12.0mm	B 48/28/48/12	152,00
013160	Standard Implant, φ4.8mm RN, SLA 14.0mm	B 48/28/48/14	152,00
013170	Standard Implant, φ4.8mm WN, SLA 6.0mm	B 65/28/48/6	152,00
013180	Standard Implant, φ4.8mm WN, SLA 8.0mm	B 65/28/48/8	152,00
013190	Standard Implant, φ4.8mm WN, SLA 10.0mm	B 65/28/48/10	152,00
013200	Standard Implant, φ4.8mm WN, SLA 12.0mm	B 65/28/48/12	152,00

Standard Implant

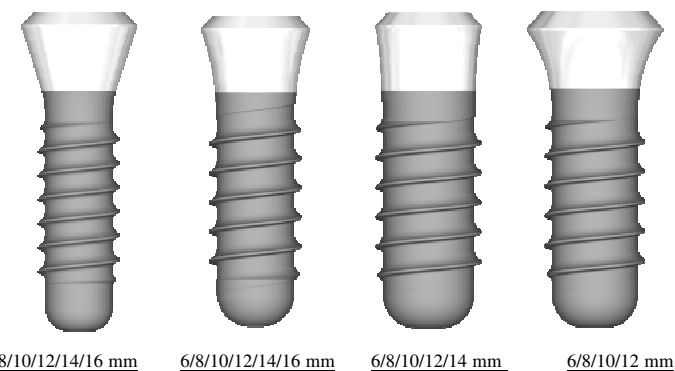

Standard Implant

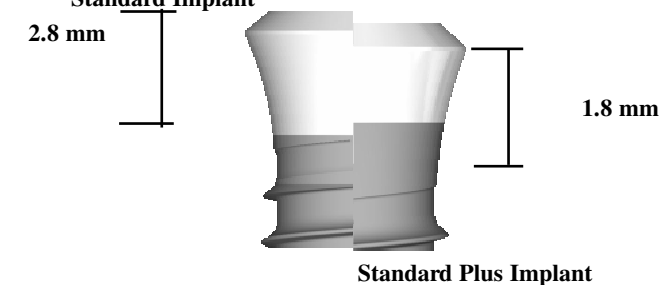

Standard Plus Implant

Bio Concept			Price (€)
P/N	Description	Size	ALV (0%)
011010	Standard Plus Implant, φ3.3mm NN, SLA 8.0mm	Z 35/18/33/8	152,00
011020	Standard Plus Implant, φ3.3mm NN, SLA 10.0mm	Z 35/18/33/10	152,00
011030	Standard Plus Implant, φ3.3mm NN, SLA 12.0mm	Z 35/18/33/12	152,00
011040	Standard Plus Implant, φ3.3mm NN, SLA 14.0mm	Z 35/18/33/14	152,00
012010	Standard Plus Implant, φ3.3mm RN, SLA 8.0mm	B 48/18/33/8	152,00
012020	Standard Plus Implant, φ3.3mm RN, SLA 10.0mm	B 48/18/33/10	152,00
012030	Standard Plus Implant, φ3.3mm RN, SLA 12.0mm	B 48/18/33/12	152,00
012040	Standard Plus Implant, φ3.3mm RN, SLA 14.0mm	B 48/18/33/14	152,00
012050	Standard Plus Implant, φ4.1mm RN, SLA 6.0mm	B 48/18/41/6	152,00
012060	Standard Plus Implant, φ4.1mm RN, SLA 8.0mm	B 48/18/41/8	152,00
012070	Standard Plus Implant, φ4.1mm RN, SLA 10.0mm	B 48/18/41/10	152,00
012080	Standard Plus Implant, φ4.1mm RN, SLA 12.0mm	B 48/18/41/12	152,00
012090	Standard Plus Implant, φ4.1mm RN, SLA 14.0mm	B 48/18/41/14	152,00
012100	Standard Plus Implant, φ4.8mm RN, SLA 6.0mm	B 48/18/48/6	152,00
012110	Standard Plus Implant, φ4.8mm RN, SLA 8.0mm	B 48/18/48/8	152,00
012120	Standard Plus Implant, φ4.8mm RN, SLA 10.0mm	B 48/18/48/10	152,00
012130	Standard Plus Implant, φ4.8mm RN, SLA 12.0mm	B 48/18/48/12	152,00
012140	Standard Plus Implant, φ4.8mm RN, SLA 14.0mm	B 48/18/48/14	152,00
012150	Standard Plus Implant, φ4.8mm WN, SLA 6.0mm	B 65/18/48/6	152,00
012160	Standard Plus Implant, φ4.8mm WN, SLA 8.0mm	B 65/18/48/8	152,00
012170	Standard Plus Implant, φ4.8mm WN, SLA 10.0mm	B 65/18/48/10	152,00
012180	Standard Plus Implant, φ4.8mm WN, SLA 12.0mm	B 65/18/48/12	152,00

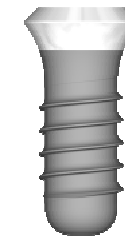
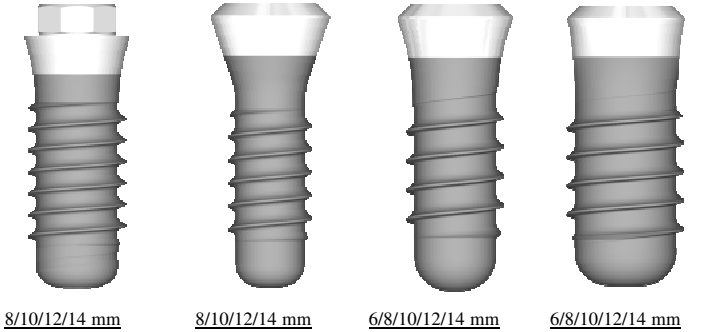
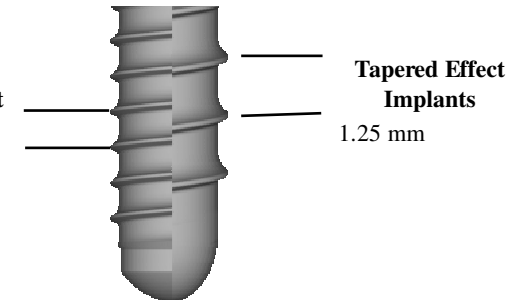
Standard Plus Implant

Standard Implant
 0.8 mm

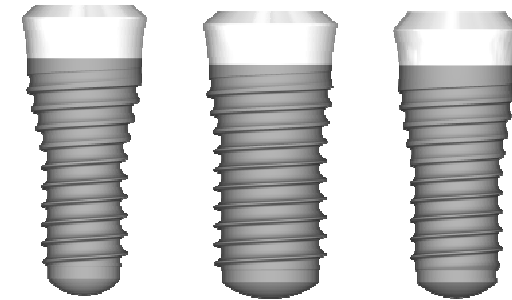
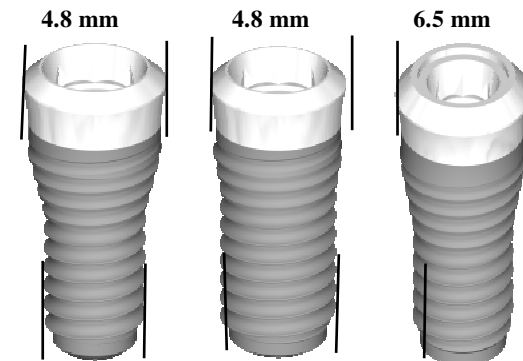
Bio Concept			Price (€)
P/N	Description	Size	ALV (0%)
014010	Tapered Effect Implant ϕ 3.3mm RN, SLA 8.0mm	J 48/18/33/8	152,00
014020	Tapered Effect Implant ϕ 3.3mm RN, SLA 10.0mm	J 48/18/33/10	152,00
014030	Tapered Effect Implant ϕ 3.3mm RN, SLA 12.0mm	J 48/18/33/12	152,00
014040	Tapered Effect Implant ϕ 3.3mm RN, SLA 14.0mm	J 48/18/33/14	152,00
014050	Tapered Effect Implant ϕ 4.1mm RN, SLA 8.0mm	J 48/18/41/8	152,00
014060	Tapered Effect Implant ϕ 4.1mm RN, SLA 10.0mm	J 48/18/41/10	152,00
014070	Tapered Effect Implant ϕ 4.1mm RN, SLA 12.0mm	J 48/18/41/12	152,00
014080	Tapered Effect Implant ϕ 4.1mm RN, SLA 14.0mm	J 48/18/41/14	152,00
014090	Tapered Effect Implant ϕ 4.8mm WN, SLA 10.0mm	J 65/18/48/10	152,00
014100	Tapered Effect Implant ϕ 4.8mm WN, SLA 12.0mm	J 65/18/48/12	152,00
014110	Tapered Effect Implant ϕ 4.8mm WN, SLA 14.0mm	J 65/18/48/14	152,00

Tapered Effect Implants

8/10/12/14 mm
8/10/12/14 mm
10/12/14 mm

3.3 mm
4.1 mm
4.8 mm

Bio Concept			Price (€)
P/N	Description	Size	ALV (0%)
021010	NN Closure screw, height 1.8mm	F3.5	32,00
021020	NN Protective cap with integral occlusal screw , ϕ 4.0mm, height 3.4mm	B 3.5-3.4	32,00
021030	NN Healing cap with integral occlusal screw , ϕ 4.0mm, height 3.4mm	X 3.5-3.4	32,00
022010	RN Closure screw, small	F4.8	32,00
022020	RN Closure screw, large, height 1.5mm	B 4.8-1.5	32,00
022030	RN Healing cap, height 2.0mm	B 4.8-2	32,00
022040	RN Healing cap, height 3.0mm	B 4.8-3	32,00
022050	RN Healing cap, height 4.5mm	B 4.8-4.5	32,00
022060	RN Healing cap, labial bevel, short, height 2.0mm	X 4.8-2	32,00
022070	RN Healing cap, labial bevel, long, height 3.5mm	X 4.8-3.5	32,00
023010	WN Closure screw	F6.5	48,00
023020	WN Healing cap, height 2.0mm	B 6.5-2	48,00
023030	WN Healing cap, height 3.0mm	B 6.5-3	48,00
023040	WN Healing cap, height 4.5mm	B 6.5-4.5	48,00
023050	WN Healing cap, labial bevel, height 2.0mm	X 6.5-2	48,00



Bio Concept			Price (€)
P/N	Description	Size	ALV (0%)
031010	NN Abutment coping□can be trimmed□height 9.0mm	3.5ZX-9	100,80
031020	NN Titanium abutment coping□15°angled, height 8.8mm	3.5JD15°-8.8	116,80
031030	NN Titanium abutment coping□20°angled, height 8.8mm	3.5JD20°-8.8	116,80
032010	RN Solid abutment 6°,height 4.0mm, yellow	4.8SX-4	116,80
032020	RN Solid abutment 6°,height 5.5mm, grew	4.8SX-5.5	116,80
032030	RN Solid abutment 6°,height 7.0mm, blue	4.8SX-7	116,80
032040	Retentive anchor, height 3.4mm	SQX-34	152,00
032050	RN 1.5 screw-retained , abutment , height 1.5mm	4.8BYH-1.5	152,00
032060	RN 2.5 screw-retained , abutment , height 2.5mm	4.8BYH-2.5	152,00
032070	RN cemented, abutment□height 5.5mm	4.8BZX-5.5	152,00
032080	RN transversal(TS) abutment, height 4.0mm	4.8BTS-4	152,00
032090	RN angled, 15°type A, height 5.7mm A	4.8BJD15°-5.7A	152,00
032100	RN angled, 15°type B, height 5.7mm B	4.8BJD15°-5.7B	152,00
032110	RN angled, 15°type A, height 6.7mm A	4.8BJD15°-6.7A	152,00
032120	RN angled, 15°type B, height 6.7mm B	4.8BJD15°-6.7B	152,00
032130	RN angled, 20°type A, height 5.9mm A	4.8BJD20°-5.9A	152,00
032140	RN angled, 20°type B, height 5.9mm B	4.8BJD20°-5.9B	152,00
032150	RN angled, 20°type A, height 6.9mm A	4.8BJD20°-6.9A	152,00
032160	RN angled, 20°type B, height 6.9mm B	4.8BJD20°-6.9B	152,00
033010	WN Solid abutment , 6°,height 4.0mm, green	6.5SX-4	116,80
033020	WN Solid abutment , 6°,height 4.0mm, brown	6.5SX-5.5	116,80
033030	WN 1.5 screw-retained , abutment , height 1.5mm	6.5BYH-1.5	152,00
033040	WN cemented, abutment□height 5.5mm	6.5BZX-5.5	152,00
033050	WN angled, 15°type A, height 5.5mm	6.5BJD15°-5.5A	152,00
033060	WN angled, 15°type B, height 5.5mm	6.5BJD15°-5.5B	152,00



Bio Concept			Price (€)
P/N	Description	Size	ALV (0%)
040010	NN Occlusal screw, length 5.0mm, Thread ϕ 1.8mm, yellow	M1.8x5	32,00
040040	SCS Occlusal screw, length 4.4mm	M2x4.4	48,00

